



AAVID
THERMALLOY

Excellence Series (PE) 60mm x 60mm x 25mm



- » Bearing Type: Ball Bearing
- » Function Type (Optional): FG Signal, RD Signal, PWM
- » Protection:
 - Auto Restart Protection
 - Polarity Reverse Protection
- » Lead Wire:
 - UL 1007 AWG #24 or Equivalent
 - Red Wire: Positive (+)
 - Black Wire: Negative (-)
 - Yellow Wire: FG Signal
 - White Wire: RD Signal
 - Blue Wire: PWM

PE SERIES 6025

DIMENSIONS DRAWING

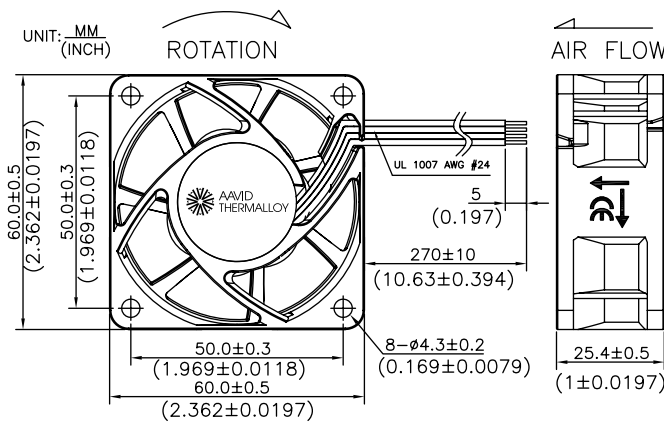

PERFORMANCE CURVES

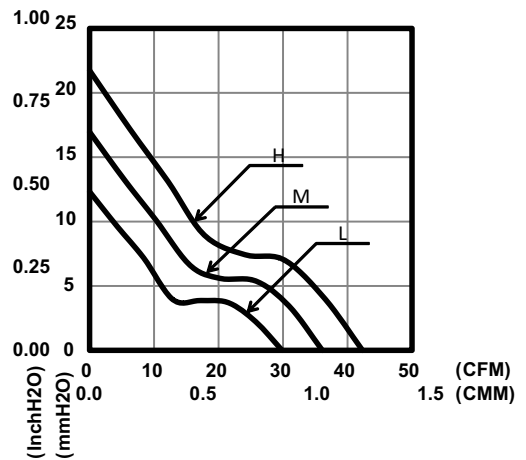

SPECIFICATION



Model	Function Type	Rated Voltage	Operating Voltage	Rated Current	Input Current	Input Power	Rated Speed	Air Flow		Air Pressure		Noise
		VDC	VDC	Amp	Amp	Watt		RPM	CMM	CFM	mmH2O	
PEAD16025BL	P000/PF00	12	6~13.8	0.27	0.21	2.52	5800	0.84	29.7	12.98	0.51	41.5
PEAD16025BM	PR00/M000	12	6~13.8	0.40	0.32	3.84	7000	1.01	35.5	17.94	0.71	46.0
PEAD16025BH	MF00/MR00	12	6~13.8	0.60	0.48	5.76	8000	1.21	42.8	24.58	0.97	50.5
PEAD26025BL	P000/PF00	24	16~27.6	0.15	0.11	2.64	5800	0.84	29.7	12.98	0.51	41.5
PEAD26025BM	PR00/M000	24	16~27.6	0.23	0.16	3.84	7000	1.01	35.5	17.94	0.71	45.5
PEAD26025BH	MF00/MR00	24	16~27.6	0.33	0.22	5.28	8000	1.21	42.8	24.58	0.97	50.5
PEAD46025BL	P000/PF00	48	30~55.2	0.10	0.06	2.88	5800	0.84	29.7	12.98	0.51	41.5
PEAD46025BM	PR00/M000	48	30~55.2	0.16	0.10	4.80	7000	1.01	35.5	17.94	0.71	45.5
PEAD46025BH	MF00/MR00	48	30~55.2	0.23	0.14	6.72	8000	1.21	42.8	24.58	0.97	50.5

* Specifications are subject to change without notice